

LM741 Operational Amplifier

General Description

The LM741 series are general purpose operational amplifiers which feature improved performance over industry standards like the LM709. They are direct, plug-in replacements for the 709C, LM201, MC1439 and 748 in most applications.

The amplifiers offer many features which make their application nearly foolproof: overload protection on the input and output, no latch-up when the common mode range is exceeded, as well as freedom from oscillations.

The LM741C/LM741E are identical to the LM741/LM741A except that the LM741C/LM741E have their performance guaranteed over a 0°C to +70°C temperature range, instead of -55°C to +125°C.

Schematic Diagram

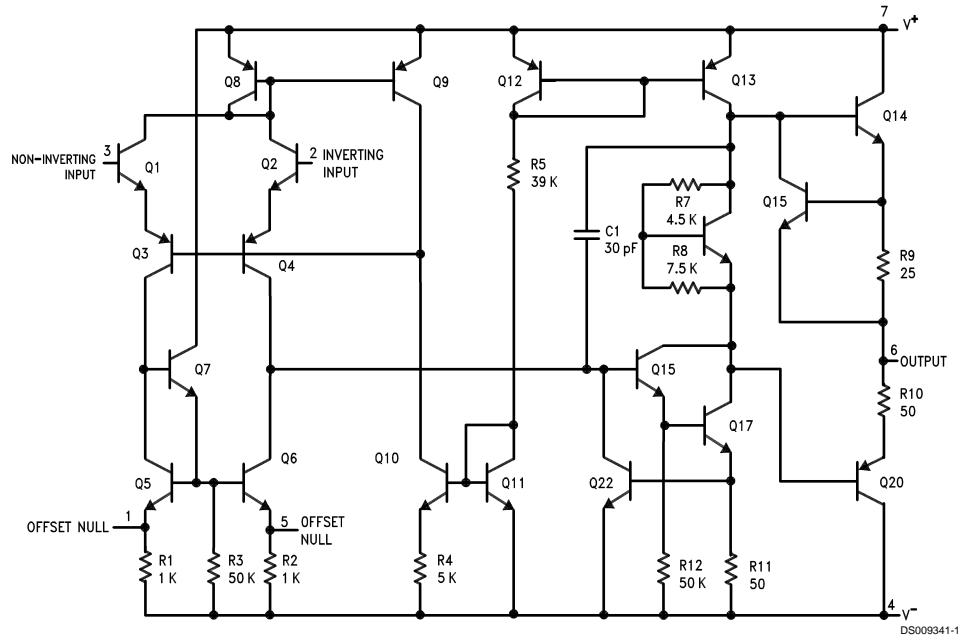

Offset Nulling Circuit

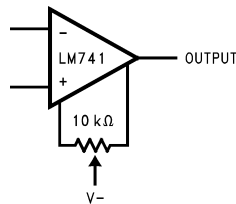

DS009341-7

Absolute Maximum Ratings (Note 1)

If Military/Aerospace specified devices are required, please contact the National Semiconductor Sales Office/Distributors for availability and specifications.

(Note 6)

	LM741A	LM741E	LM741	LM741C
Supply Voltage	±22V	±22V	±22V	±18V
Power Dissipation (Note 2)	500 mW	500 mW	500 mW	500 mW
Differential Input Voltage	±30V	±30V	±30V	±30V
Input Voltage (Note 3)	±15V	±15V	±15V	±15V
Output Short Circuit Duration	Continuous	Continuous	Continuous	Continuous
Operating Temperature Range	-55°C to +125°C	0°C to +70°C	-55°C to +125°C	0°C to +70°C
Storage Temperature Range	-65°C to +150°C	-65°C to +150°C	-65°C to +150°C	-65°C to +150°C
Junction Temperature	150°C	100°C	150°C	100°C
Soldering Information				
N-Package (10 seconds)	260°C	260°C	260°C	260°C
J- or H-Package (10 seconds)	300°C	300°C	300°C	300°C
M-Package				
Vapor Phase (60 seconds)	215°C	215°C	215°C	215°C
Infrared (15 seconds)	215°C	215°C	215°C	215°C
See AN-450 "Surface Mounting Methods and Their Effect on Product Reliability" for other methods of soldering surface mount devices.				
ESD Tolerance (Note 7)	400V	400V	400V	400V

Electrical Characteristics (Note 4)

Parameter	Conditions	LM741A/LM741E			LM741			LM741C			Units
		Min	Typ	Max	Min	Typ	Max	Min	Typ	Max	
Input Offset Voltage	$T_A = 25^\circ\text{C}$										
	$R_S \leq 10\text{ k}\Omega$		0.8	3.0		1.0	5.0		2.0	6.0	mV
	$R_S \leq 50\Omega$										mV
Average Input Offset Voltage Drift	$T_{AMIN} \leq T_A \leq T_{AMAX}$			4.0							mV
	$R_S \leq 50\Omega$						6.0			7.5	mV
	$R_S \leq 10\text{ k}\Omega$										$\mu\text{V}/^\circ\text{C}$
Average Input Offset Voltage Drift			15								$\mu\text{V}/^\circ\text{C}$
Input Offset Voltage Adjustment Range	$T_A = 25^\circ\text{C}, V_S = \pm 20\text{V}$	±10				±15			±15		mV
Input Offset Current	$T_A = 25^\circ\text{C}$		3.0	30		20	200		20	200	nA
	$T_{AMIN} \leq T_A \leq T_{AMAX}$			70		85	500			300	nA
Average Input Offset Current Drift				0.5							$\text{nA}/^\circ\text{C}$
Input Bias Current	$T_A = 25^\circ\text{C}$		30	80		80	500		80	500	nA
	$T_{AMIN} \leq T_A \leq T_{AMAX}$			0.210			1.5			0.8	μA
Input Resistance	$T_A = 25^\circ\text{C}, V_S = \pm 20\text{V}$	1.0	6.0		0.3	2.0		0.3	2.0		$\text{M}\Omega$
	$T_{AMIN} \leq T_A \leq T_{AMAX}, V_S = \pm 20\text{V}$	0.5									$\text{M}\Omega$
Input Voltage Range	$T_A = 25^\circ\text{C}$							±12	±13		V
	$T_{AMIN} \leq T_A \leq T_{AMAX}$				±12	±13					V

Electrical Characteristics (Note 4) (Continued)

Parameter	Conditions	LM741A/LM741E			LM741			LM741C			Units
		Min	Typ	Max	Min	Typ	Max	Min	Typ	Max	
Large Signal Voltage Gain	$T_A = 25^\circ\text{C}$, $R_L \geq 2\text{ k}\Omega$ $V_S = \pm 20\text{V}$, $V_O = \pm 15\text{V}$ $V_S = \pm 15\text{V}$, $V_O = \pm 10\text{V}$	50			50	200		20	200		V/mV V/mV
	$T_{AMIN} \leq T_A \leq T_{AMAX}$, $R_L \geq 2\text{ k}\Omega$, $V_S = \pm 20\text{V}$, $V_O = \pm 15\text{V}$ $V_S = \pm 15\text{V}$, $V_O = \pm 10\text{V}$	32			25			15			V/mV V/mV
	$V_S = \pm 5\text{V}$, $V_O = \pm 2\text{V}$	10									V/mV
Output Voltage Swing	$V_S = \pm 20\text{V}$ $R_L \geq 10\text{ k}\Omega$ $R_L \geq 2\text{ k}\Omega$	± 16 ± 15									V V
	$V_S = \pm 15\text{V}$ $R_L \geq 10\text{ k}\Omega$ $R_L \geq 2\text{ k}\Omega$				± 12 ± 10	± 14 ± 13		± 12 ± 10	± 14 ± 13		V V
Output Short Circuit Current	$T_A = 25^\circ\text{C}$	10	25	35		25			25		mA
	$T_{AMIN} \leq T_A \leq T_{AMAX}$	10		40							mA
Common-Mode Rejection Ratio	$T_{AMIN} \leq T_A \leq T_{AMAX}$ $R_S \leq 10\text{ k}\Omega$, $V_{CM} = \pm 12\text{V}$ $R_S \leq 50\Omega$, $V_{CM} = \pm 12\text{V}$	80	95		70	90		70	90		dB dB
	$T_{AMIN} \leq T_A \leq T_{AMAX}$, $V_S = \pm 20\text{V}$ to $V_S = \pm 5\text{V}$ $R_S \leq 50\Omega$ $R_S \leq 10\text{ k}\Omega$	86	96		77	96		77	96		dB dB
Transient Response	$T_A = 25^\circ\text{C}$, Unity Gain	Rise Time	0.25	0.8		0.3			0.3		μs
		Overshoot	6.0	20		5			5		%
Bandwidth (Note 5)	$T_A = 25^\circ\text{C}$	0.437	1.5								MHz
Slew Rate	$T_A = 25^\circ\text{C}$, Unity Gain	0.3	0.7			0.5			0.5		V/ μs
Supply Current	$T_A = 25^\circ\text{C}$					1.7	2.8		1.7	2.8	mA
Power Consumption	$T_A = 25^\circ\text{C}$ $V_S = \pm 20\text{V}$ $V_S = \pm 15\text{V}$		80	150							mW mW
	LM741A $V_S = \pm 20\text{V}$ $T_A = T_{AMIN}$ $T_A = T_{AMAX}$			165 135							mW mW
LM741E	$V_S = \pm 20\text{V}$ $T_A = T_{AMIN}$ $T_A = T_{AMAX}$			150 150							mW mW
	LM741 $V_S = \pm 15\text{V}$ $T_A = T_{AMIN}$ $T_A = T_{AMAX}$					60 45	100 75				mW mW

Note 1: "Absolute Maximum Ratings" indicate limits beyond which damage to the device may occur. Operating Ratings indicate conditions for which the device is functional, but do not guarantee specific performance limits.

Electrical Characteristics (Note 4) (Continued)

Note 2: For operation at elevated temperatures, these devices must be derated based on thermal resistance, and T_j max. (listed under "Absolute Maximum Ratings"). $T_j = T_A + (\theta_{JA} P_D)$.

Thermal Resistance	Cerdip (J)	DIP (N)	HO8 (H)	SO-8 (M)
θ_{JA} (Junction to Ambient)	100°C/W	100°C/W	170°C/W	195°C/W
θ_{JC} (Junction to Case)	N/A	N/A	25°C/W	N/A

Note 3: For supply voltages less than $\pm 15V$, the absolute maximum input voltage is equal to the supply voltage.

Note 4: Unless otherwise specified, these specifications apply for $V_S = \pm 15V$, $-55^\circ C \leq T_A \leq +125^\circ C$ (LM741/LM741A). For the LM741C/LM741E, these specifications are limited to $0^\circ C \leq T_A \leq +70^\circ C$.

Note 5: Calculated value from: BW (MHz) = $0.35/\text{Rise Time}(\mu s)$.

Note 6: For military specifications see RETS741X for LM741 and RETS741AX for LM741A.

Note 7: Human body model, 1.5 k Ω in series with 100 pF.

Connection Diagram

Metal Can Package

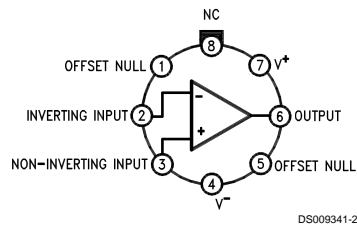

DS009341-2

Note 8: LM741H is available per JM38510/10101

**Order Number LM741H, LM741H/883 (Note 8),
LM741AH/883 or LM741CH
See NS Package Number H08C**

Dual-In-Line or S.O. Package

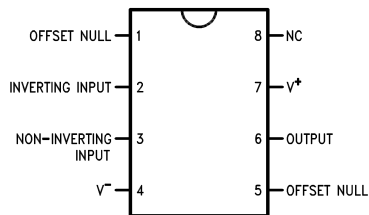

DS009341-3

**Order Number LM741J, LM741J/883,
LM741CM, LM741CN or LM741EN
See NS Package Number J08A, M08A or N08E**

Ceramic Dual-In-Line Package

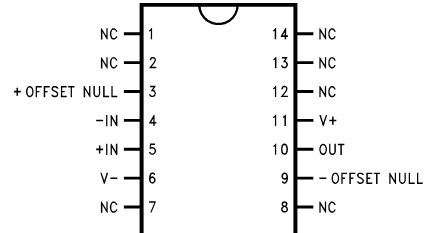

DS009341-5

Note 9: also available per JM38510/10101

Note 10: also available per JM38510/10102

**Order Number LM741J-14/883 (Note 9),
LM741AJ-14/883 (Note 10)
See NS Package Number J14A**

Ceramic Flatpak

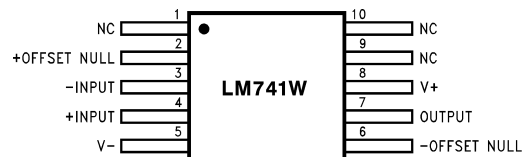

DS009341-6

**Order Number LM741W/883
See NS Package Number W10A**

TYPICAL CHARACTERISTICS

**MAXIMUM PEAK OUTPUT VOLTAGE
vs
FREQUENCY**

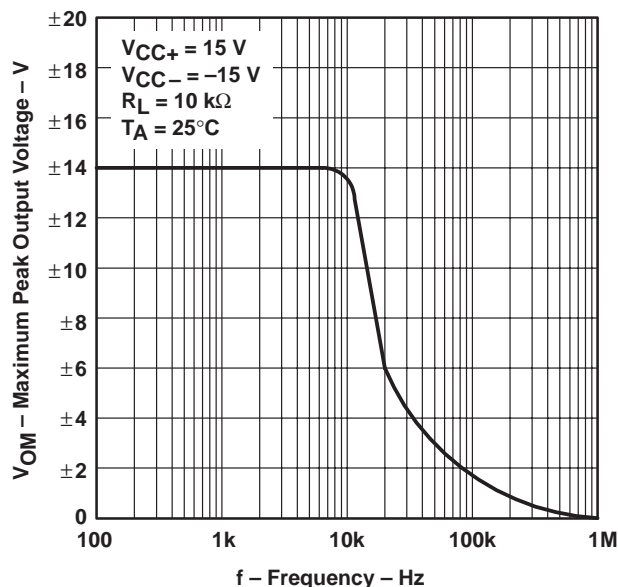

Figure 6

**OPEN-LOOP SIGNAL DIFFERENTIAL
VOLTAGE AMPLIFICATION
vs
SUPPLY VOLTAGE**

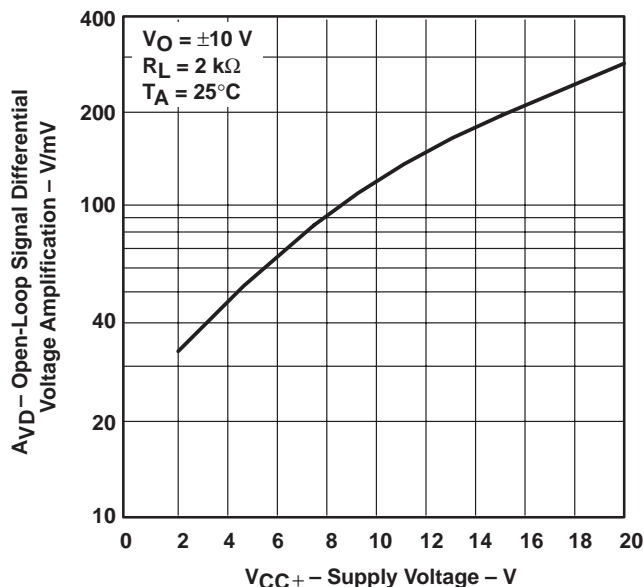
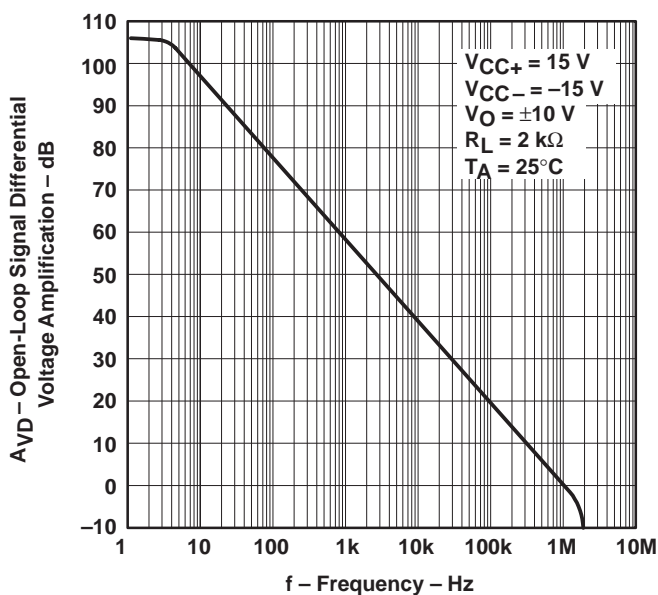

Figure 7

**OPEN-LOOP LARGE-SIGNAL DIFFERENTIAL
VOLTAGE AMPLIFICATION
vs
FREQUENCY**



TYPICAL CHARACTERISTICS

COMMON-MODE REJECTION RATIO
 VS
 FREQUENCY

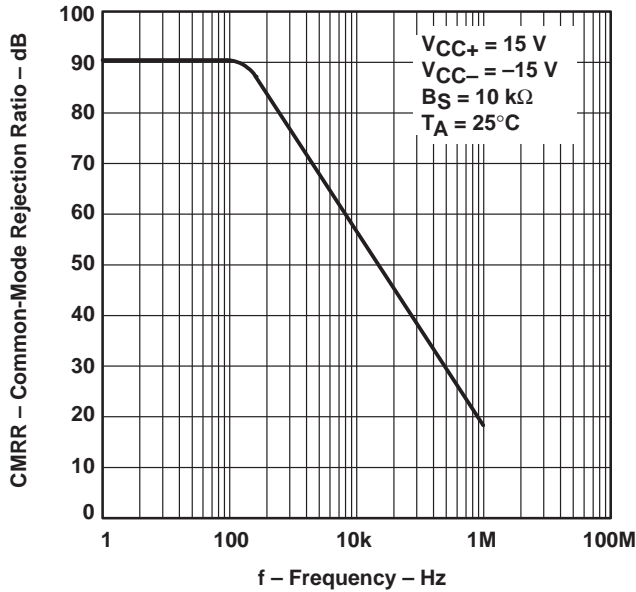

Figure 8

OUTPUT VOLTAGE
 VS
 ELAPSED TIME

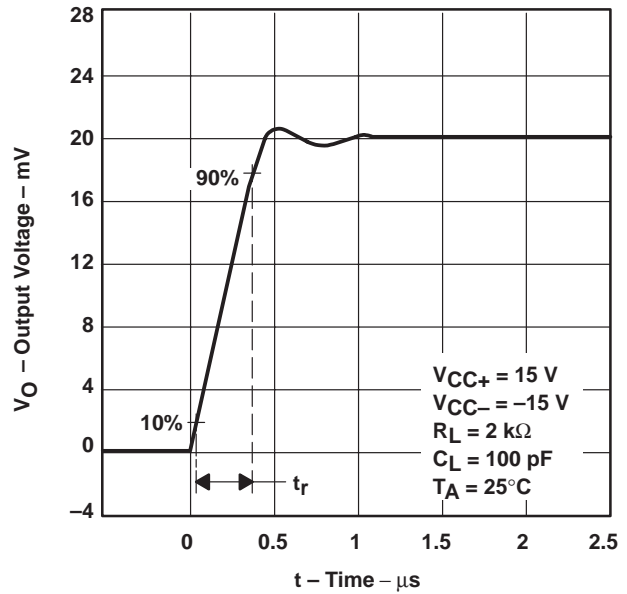

Figure 9

VOLTAGE-FOLLOWER
 LARGE-SIGNAL PULSE RESPONSE

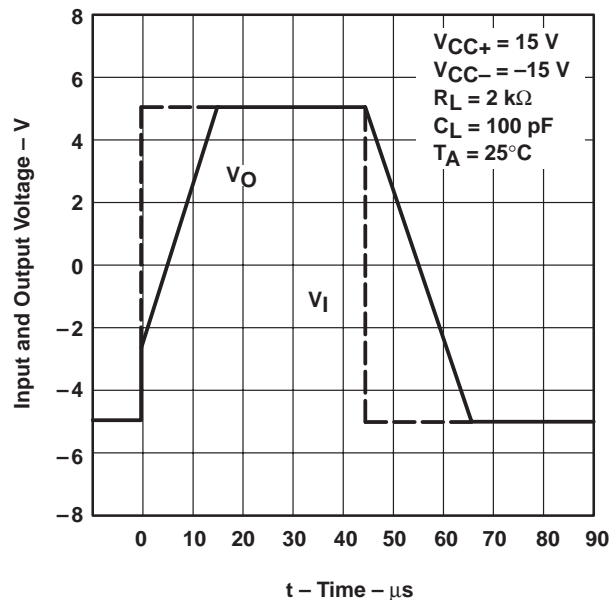

Figure 10